

**CARATTERISTICHE**

- Uscite: 12 canali
- BUS+SEQUENCER+FADER+DIMMER+DRIVER
- Ingresso: DC 12/24/48 Vdc (Range di alimentazione 10,8Vdc – 53,5Vdc)
- Comando BUS: DMX512-A+RDM, DALI, MODBUS
- Controllo: Dimmer, Dim to Warm, Bianco Dinamico, RGB, RGBW
- Uscite in Tensione per carichi R-L-C
- Efficienza Tipica > 95%
- Variazione della Temperatura Colore verso il caldo al diminuire dell'intensità luminosa (Dim to Warm)
- Nella modalità RGB e RGBW possibilità di gestire in maniera sincrona i singoli colori
- Regolazione della luminosità fino allo spegnimento completo (Dim to Dark)
- Livello minimo di luminosità: 0,1% (1% in modalità Push)
- Modulazione D-PWM
- Frequenza D-PWM impostabile: 300 / 600 / 1200 Hz
- Curva di regolazione impostabile: Lineare / Quadratica / Esponenziale
- Accensione e spegnimento morbidi
- Regolazione morbida della luminosità
- Range di temperatura esteso
- 100% Test funzionale – Garanzia 5 anni

→ Per il Manuale dispositivo completo e aggiornato consultare il sito internet del produttore: <http://www.dalcnet.com>

➤ **VARIANTI A TENSIONE COSTANTE (anodo comune)**

Applicazione (12 – canali di uscita): Dimmer, Dim to Warm, Tunable White, RGB , RGBW

CODICE	Tensione di ingresso	Uscita	Canali	Comando	
DLD1248-12CV-DMX	12/24/48V DC	1x20A max	12	DMX	PROFESSIONAL
		12x2A (max 20A tot)			
DLD1248-12CV-MODBUS	12/24/48V DC	1x20A max	12	MODBUS RTU	PROFESSIONAL
		12x2A (max 20A tot)			
DLD1248-12CV-DALI	12/24/48V DC	1x20A max	12	DALI	PROFESSIONAL
		12x2A (max 20A tot)			

➤ **PROTEZIONI**

<b>OTP</b>	Protezione da sovra-temperatura <sup>1</sup>
<b>OVP</b>	Protezione da sovralimentazione
<b>UVP</b>	Protezione da sottoalimentazione
<b>RVP</b>	Protezione da inversione della polarità <sup>2</sup>
<b>IFP</b>	Protezione con fusibile in ingresso <sup>2</sup>
<b>OCP</b>	Protezione da circuito aperto in uscita
<b>CLP</b>	Protezione con limitatore di corrente in uscita

➤ **NORMATIVE DI RIFERIMENTO**

<sup>1</sup> protezione sulle uscite

<sup>2</sup> protezione sulla logica di controllo

EN 61347-1	Lamp controlgear - Part 1: General and safety requirements
EN 61000-3-2	Electromagnetic compatibility (EMC) - Part 3-2: Limits - Limits for harmonic current emissions (equipment input current $\leq 16$ A per phase)
EN 61000-3-3	Electromagnetic compatibility (EMC) - Part 3-3: Limits - Limitation of voltage changes, voltage fluctuations and flicker in public low-voltage supply systems, for equipment with rated current $\leq 16$ A per phase and not subject to conditional connection
EN 62384	DC or AC supplied electronic control gear for LED modules - Performance requirements
EN 55015	Limits and methods of measurement of radio disturbance characteristics of electrical lighting and similar equipment
EN 61547	Equipment for general lighting purposes - EMC immunity requirements
EN 50581	Technical documentation for the assessment of electrical and electronic products with respect to the restriction of hazardous substances
IEC/EN 62386-101	Digital addressable lighting interface - Part 101: General requirements - System
IEC/EN 62386-102	Digital addressable lighting interface - Part 102: General requirements - Control gear
IEC/EN 62386-207	Digital addressable lighting interface - Part 207: Particular requirements for control gear – LED modules (device type 6)
ANSI E1.11	Entertainment Technology - USITT DMX512-A - Asynchronous Serial Digital Data Transmission Standard for Controlling Lighting Equipment and Accessories
ANSI E1.20	Entertainment Technology-RDM-Remote Device Management over USITT DMX512 Networks
-	MODBUS APPLICATION PROTOCOL SPECIFICATION V1.1b

### ➤ SPECIFICHE TECNICHE

		Variante	
		Tensione costante	
Tensione di alimentazione		DC min: 10,8 Vdc .. max: 53,5 Vdc	
Tensione di uscita		=Vin	
Corrente assorbita		max 20A	
Corrente di uscita		12x max 2 A (max 20A totali)	1x max 20 A (12 canali parallelati)
Potenza nominale <sup>3</sup>	@12V	24 W/ch	240 Wtot
	@24V	48 W/ch	480 Wtot
	@48V	96 W/ch	960 Wtot
Potenza assorbita in assenza di comando		<500mW	
Uscita in tensione per carichi		R – L – C	
Intervento termico		150 °C	
Frequenza di dimmerazione		300Hz / 600Hz / 1200Hz	
Risoluzione D-PWM		16 bit	
Range D-PWM		0,1% - 100%	
Temperatura di stoccaggio		min: -40 max: +60 °C	
Temperatura ambiente <sup>3</sup>		min: -40 max: +60 °C	
Cablaggio Button & Bus		1.5mm <sup>2</sup> solid – 1 mm <sup>2</sup> stranded - 30/14 AWG	
Spellatura Power & Leds		2.5mm <sup>2</sup> solid – 1.5 mm <sup>2</sup> stranded - 30/12 AWG	
Classe di protezione		IP10	
Materiale d'involucro		Plastica	
Unità di imballo (pezzi/unità)		Single Carton Box 1 pz	
Dimensioni Meccaniche		143 x 91 x 62 mm – DIN RAIL 8M	
Dimensioni Confezione		156 x 124 x 71 mm	
Peso		205g	

<sup>3</sup> Valore massimo, dipendente dalle condizioni di ventilazione

### ➤ INSTALLAZIONE

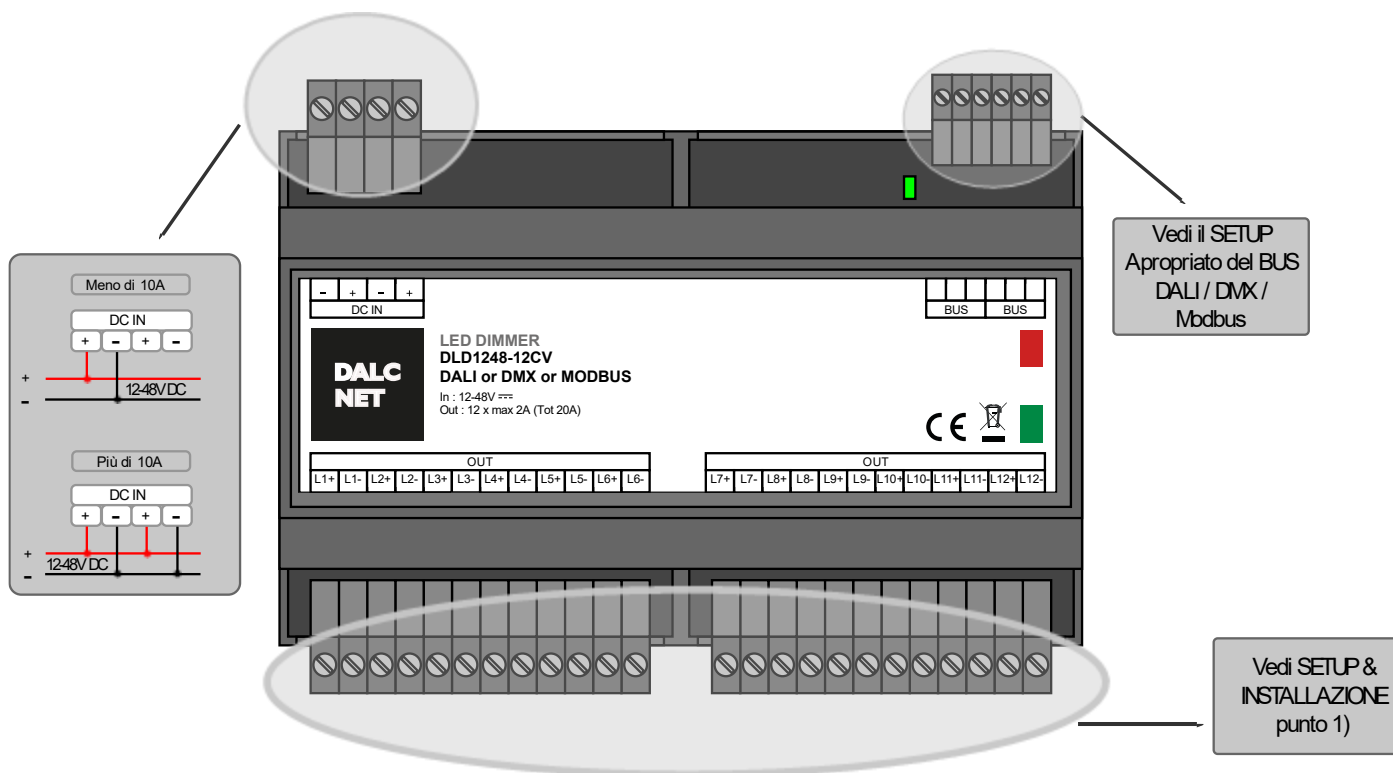

### ➤ DIMENSIONI MECCANICHE: (morsetti esclusi)

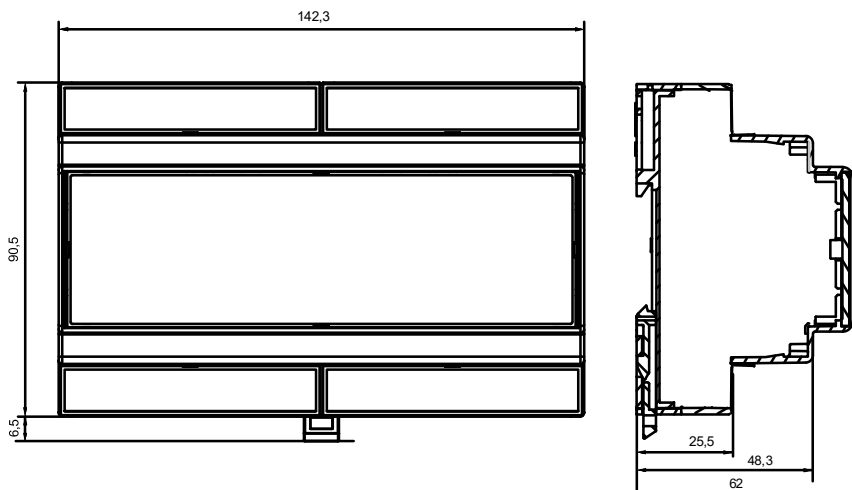

## ➤ APERTURA FRONTALINO

Per la configurazione del dip-switch e dei selettori rotativi è necessario aprire il frontalino del dispositivo. Si veda figura sottostante.

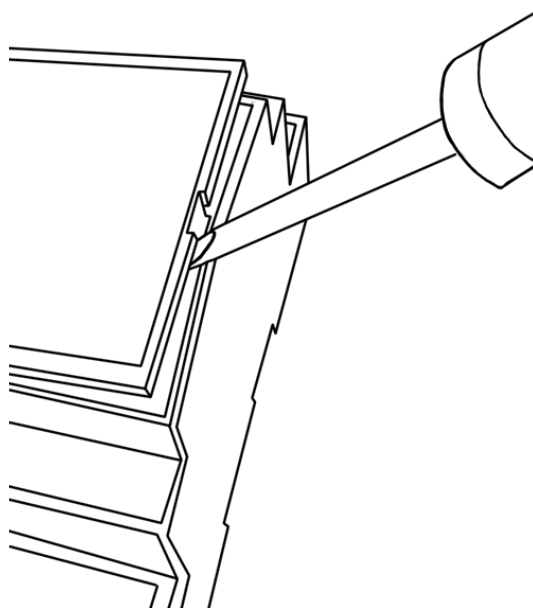

## ➤ NOTE TECNICHE

### Installazione:

- L'installazione e la manutenzione deve essere eseguita solamente da personale qualificato nel rispetto delle normative vigenti.
- Il prodotto deve essere installato all'interno di un quadro elettrico protetto da sovratensioni.
- Il prodotto deve essere installato in posizione verticale o orizzontale con il frontalino/etichetta verso l'alto o in verticale; non sono ammesse altre posizioni. Non è ammessa la posizione bottom-up (con frontalino/etichetta in basso).
- Mantenere separati i circuiti a 230V (LV) e i circuiti non SELV dai circuiti a bassissima tensione di sicurezza (SELV) e da tutti i collegamenti di questo prodotto. E' assolutamente vietato collegare, per qualunque motivo, direttamente o indirettamente, la tensione di rete 230V al bus o ad altri parti del circuito.

### Alimentazione:

- Per l'alimentazione utilizzare solamente alimentatori di tipo SELV con corrente limitata, protezione da corto circuito e di potenza opportunamente dimensionata. In caso di alimentatori provvisti di morsetti di terra, collegare obbligatoriamente TUTTI i punti di terra di protezione (PE = Protection Earth) ad un impianto di messa a terra eseguito a regola d'arte e certificato.
- I cavi di collegamento tra la sorgente di alimentazione a bassissima tensione ed il prodotto devono essere dimensionati correttamente e vanno isolati da eventuali cablaggi o parti a tensione non SELV. Utilizzare cavi in doppio isolamento.
- In caso di correnti di uscita totali superiori a 10A collegare all'alimentazione entrambe le coppie di ingresso di alimentazione "V+" e "V-"
- Dimensionare la potenza dell'alimentatore in riferimento al carico collegato al dispositivo. Nel caso l'alimentatore sia sovradimensionato rispetto alla massima corrente assorbita, inserire una protezione contro le sovra-correnti tra l'alimentatore e il dispositivo.

### Comandi:

- La lunghezza dei cavi di collegamento ai bus (DMX512, Modbus, DALI, o altro) deve rispettare quanto definito dalle specifiche dei rispettivi protocolli e dalle normative vigenti; vanno isolati da eventuali cablaggi o parti a tensione non SELV. Utilizzare cavi in doppio isolamento schermati e twistati.
- Tutti i dispositivi ed i segnali di controllo collegati ai bus (DMX512, Modbus, DALI o altro) devono essere di tipo SELV (gli apparecchi collegati devono essere SELV o comunque fornire un segnale SELV).

### Uscite:

- La lunghezza dei cavi di collegamento tra il prodotto e i moduli LED devono essere inferiori a 10m; i cavi devono essere dimensionati correttamente e vanno isolati da eventuali cablaggi o parti a tensione non SELV. Utilizzare cavi in doppio isolamento schermati e twistati.

### ➤ SETUP & INSTALLAZIONE

Un dip-switch a 12 vie (sotto il frontalino) offre una vasta scelta di configurazioni possibili.



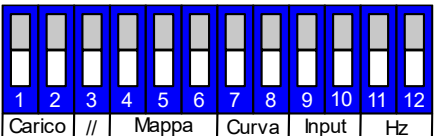



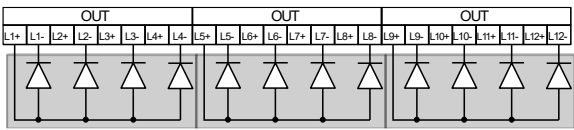
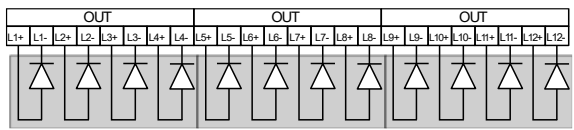
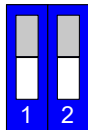

Nota: Impostazioni di fabbrica = tutto a OFF

Funzioni		<ul style="list-style-type: none"> <li>Switches da 1 a 2:</li> </ul>	<b>Tipologia del carico LED</b>
		<ul style="list-style-type: none"> <li>Switch 3:</li> </ul>	<b>Uscite in parallelo</b>
		<ul style="list-style-type: none"> <li>Switches da 4 a 6:</li> </ul>	<b>Mappa</b>
		<ul style="list-style-type: none"> <li>Switches da 7 a 8:</li> </ul>	<b>Curva</b>
		<ul style="list-style-type: none"> <li>Switches da 9 a 10:</li> </ul>	<b>Riservato</b>
		<ul style="list-style-type: none"> <li>Switches da 11 a 12:</li> </ul>	<b>Frequenza di dimmerazione impostabile</b>

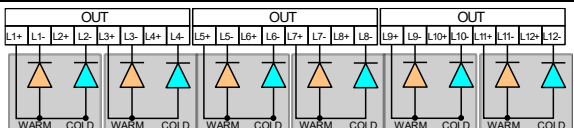
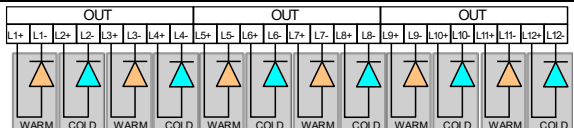
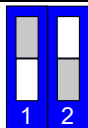
1)Settaggio della tipologia di carico e gestione dei canali singolarmente: Switches da 1 a 2. Lo switch 3 è impostato in OFF

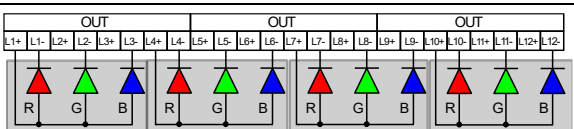
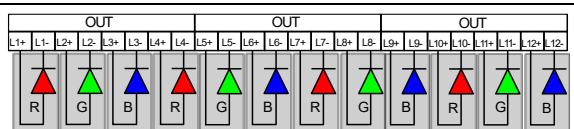
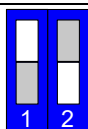
Per la gestione dei canali singolarmente lo Switch 3 deve essere impostato in OFF:

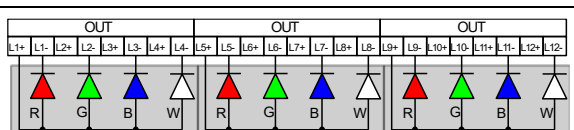
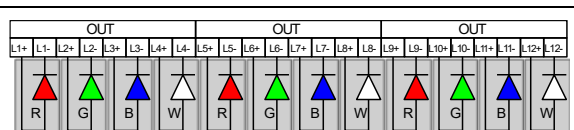







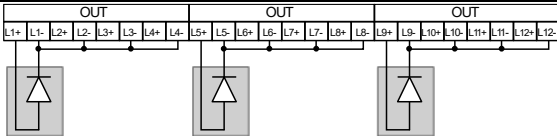
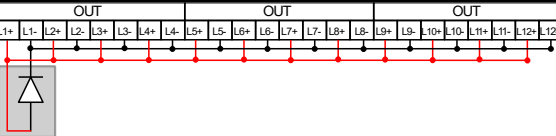
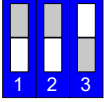

Tipologia di carico	Collegamento ad Anodo Comune <sup>4</sup>	Collegamento ad Anodo Indipendente (corrente tot. 0-20A max)	DIP
 Bianco			
 Bianco Dinamico			
 RGB			
 RGBW			

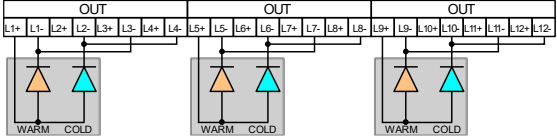
Settaggio della tipologia di carico e gestione dei canali in parallelo a seconda della connessione d'uscita desiderata:

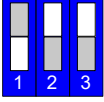

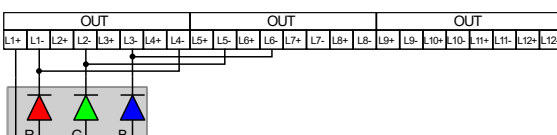
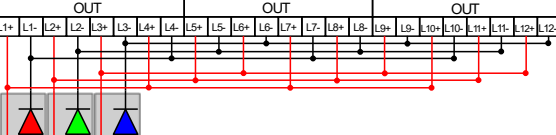
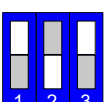

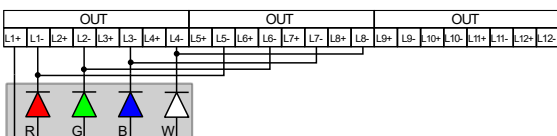
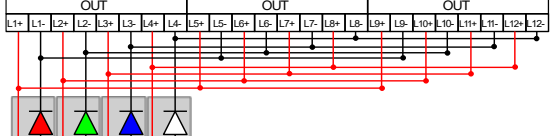
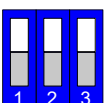
<sup>4</sup> NOTA: I collegamenti ad anodo comune non devono superare i 10A

Switches da 1 a 2. Lo Switch 3 deve essere impostato in ON





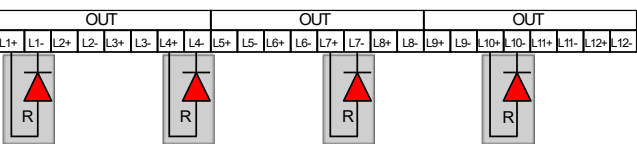
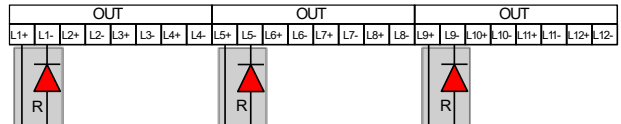
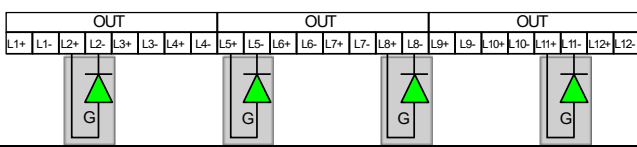
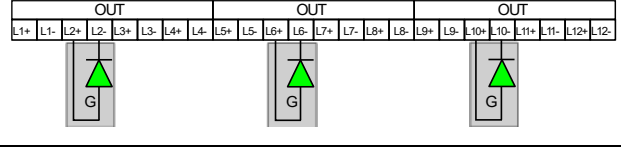
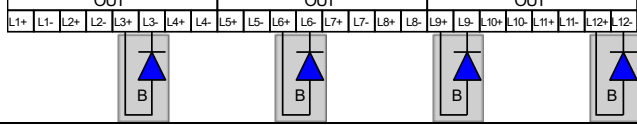
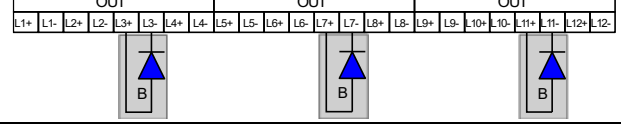

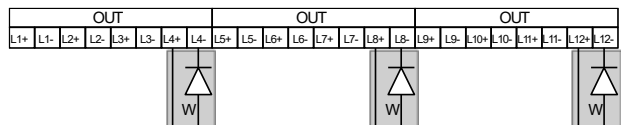





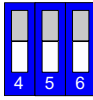
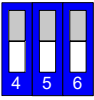
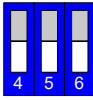
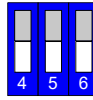
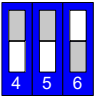
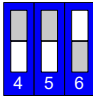
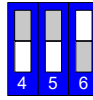

	Collegamento ad Anodo Comune (*)	Collegamento ad Anodo Indipendente (corrente tot. 0-20A max)	DIP
			
			
			
			

NOTE: Con questo settaggio è possibile comandare le uscite in parallelo per ottenere un canale d'uscita con intensità di corrente più elevata (Macro Dimmer). I collegamenti a anodo comune non devono superare i 10A. Nel caso si collegasse un carico maggiore ai 10A bisogna parallelare tutte le uscite positive e tutte le uscite negative del LedDimmer, MAX 20A. Per il corretto collegamento vedere la colonna "Collegamento ad Anodo Indipendente".

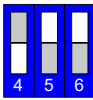
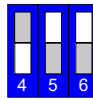

**Nella modalità RGB e RGBW è possibile comandare tutti i canali del Rosso "R" o del verde "G" o del blu "B" o del bianco "W" in modalità sincrona.**

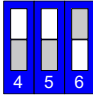
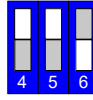
<p>Funzione RGB Comando sincrono dei singoli colori R, G e B</p> 	<p>Funzione RGBW Comando sincrono dei singoli R, G, B e W</p> 
	
	
	
	

2)Settaggio della Mappa: Switches da 4 a 6

Carico Bianco	Carico Bianco Dinamico	Carico RGB	Carico RGBW
			
Dimmer 	Dimmer 	Dimmer 	Dimmer 
	Dim to Warm 	Dim to Warm 	Dim to Warm 
	Bianco Dinamico 	Bianco Dinamico 	Bianco Dinamico 
		Smart HSV Intensità, Correzione della temperatura, Selezione colore & rotazione, Saturazione e strobo 	Smart HSV Intensità, Correzione della temperatura, Selezione colore & rotazione, Saturazione e strobo 
		RGB 	RGB Conversione RGB→RGBW 
		RGBW Conversione RGBW→RGB 	RGBW 
		Master+RGB+Strobe 	Master+RGB+Strobe Conversione RGB→RGBW 
		Master+RGBW+Strobe Conversione RGBW→RGB 	Master+RGBW+Strobe 

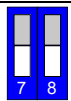
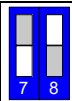
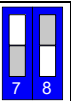
## 3) Settaggio della Curva di Dimmerazione: Switches da 7 a 8

Default (by bus type) 	Quadratica 	Esponenziale 	Lineare 
--	--	--	--

## 4) Switches da 9 a 10: Configurazioni Riservate

## 5) Settaggio della Frequenza di Dimmerazione: Switches da 11 a 12

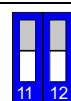
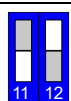
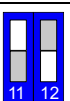
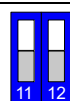
300Hz 	600Hz 	1200Hz 	Riservato 
---	---	--	--

➤ **FUNZIONAMENTO TRAMITE BUS DALI**

Con la modalità **DALI BUS** lo stato delle luci viene gestito tramite un controllo esterno DALI

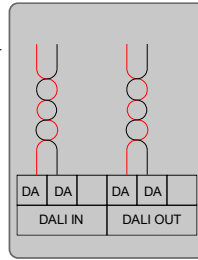
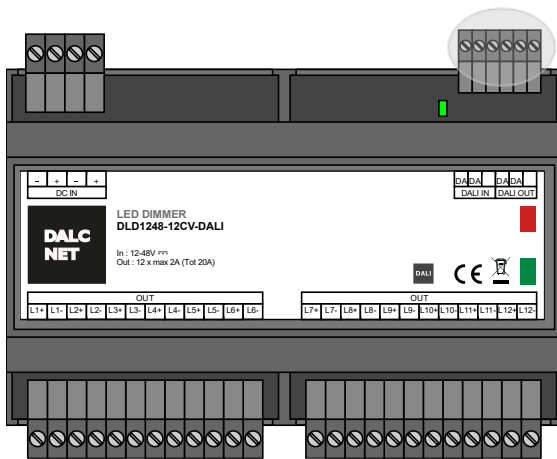

**Caratteristiche**

- Bus DALI

**Normative di riferimento relative al DALI BUS**

IEC/EN 62386-101	Digital addressable lighting interface – Part 101: General requirements - System
IEC/EN 62386-102	Digital addressable lighting interface – Part 102: General requirements – Control gear
IEC/EN 62386-207	Digital addressable lighting interface – Part 207: Particular requirements for control gear – LED modules (device type 6)

**Led di segnalazione:**

Nel caso non vi sia l'alimentazione del BUS o vi sia un errore del BUS il Led di segnalazione lampeggia velocemente (2 impulsi al secondo).  
 Nel caso il BUS sia alimentato ma vi è un errore del BUS il Led di segnalazione lampeggia lentamente (1 impulso al secondo)  
 Nel caso vi sia il segnale del BUS connesso e correttamente funzionante il Led rimane acceso fisso.

**Indirizzamento:**

Tramite selettori	✓
Metodo semplificato (One ballast connected at time)	✓
Indirizzamento da BUS (Random Address Allocation)	✓

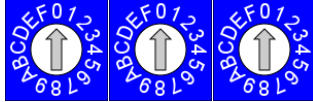
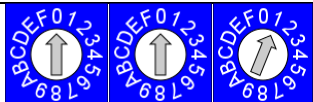
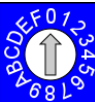
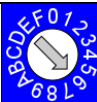
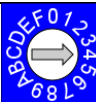
DALI	000 (Default)					Indirizzo impostato dal BUS DALI
	Da 001		A 064			

**MAPPA INDIRIZZI – DALI**



## MAPPA: DIMMER

MAPPA	Funzione	
DIMMER	Dimmer	Dimmer (Valore Intensità) 0 .. 254

## ASSEGNAZIONE INDIRIZZI IN BASE ALLA TIPOLOGIA DEL CARICO: Bianco, Bianco Dinamico, RGB e RGBW



## Gestione dei canali singolarmente (DIP 3 settato in "OFF")

Addr	Funzione	OUT	Addr	Fuunzione	OUT	Addr	Funzione	OUT	Addr	Funzione	OUT
+0	Dimmer	CH 1	+0	Dimmer	CH 1-2	+0	Dimmer	CH 1-3	+0	Dimmer	CH 4
+1	Dimmer	CH 2	+1	Dimmer	CH 3-4	+1	Dimmer	CH 4-6	+1	Dimmer	CH 8
+2	Dimmer	CH 3	+2	Dimmer	CH 5-6	+2	Dimmer	CH 7-9	+2	Dimmer	CH 12
+3	Dimmer	CH 4	+3	Dimmer	CH 7-8	+3	Dimmer	CH 10-12			
+4	Dimmer	CH 5	+4	Dimmer	CH 9-10						
+5	Dimmer	CH 6	+5	Dimmer	CH 11-12						
+6	Dimmer	CH 7									
+7	Dimmer	CH 8									
+8	Dimmer	CH 9									
+9	Dimmer	CH 10									
+10	Dimmer	CH 11									
+11	Dimmer	CH 12									

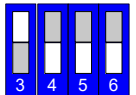

## Gestione dei canali in parallelo (DIP 3 settato in "ON")

Addr	Funzione	OUT	Addr	Funzione	OUT	Addr	Funzione	OUT	Addr	Funzione	OUT
+0	Dimmer	CH TUTTI	+0	Dimmer	CH TUTTI	+0	Dimmer	CH TUTTI	+0	Dimmer	CH 4,8,12

## MAPPA: DIM TO WARM



MAPPA	Funzione	
DIM TO WARM	Dim to warm	Dimmer (Valore Intensità) 0 .. 254

ASSEGNAZIONE INDIRIZZI IN BASE ALLA TIPOLOGIA DEL CARICO

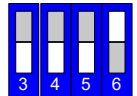
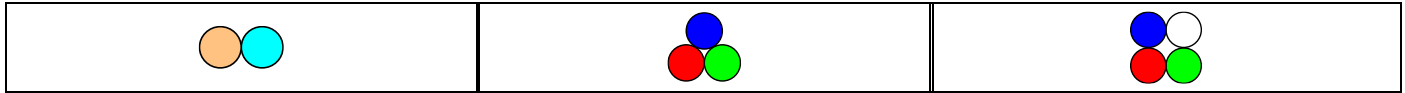

Gestione dei canali singolarmente (DIP 3 settato in "OFF")

Addr	Funzione	OUT	Addr	Funzione	OUT	Addr	Funzione	OUT
+0	Dim to warm	CH 1-2	+0	Dim to warm	CH 1,2,3	+0	Dim to warm	CH 1,2,3,4
+1	Dim to warm	CH 3-4	+1	Dim to warm	CH 4,5,6	+1	Dim to warm	CH 5,6,7,8
+2	Dim to warm	CH 5-6	+2	Dim to warm	CH 7,8,9	+2	Dim to warm	CH 9,10,11,12
+3	Dim to warm	CH 7-8	+3	Dim to warm	CH 10,11,12			
+4	Dim to warm	CH 9-10						
+5	Dim to warm	CH 11-12						

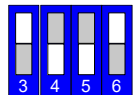

Gestione dei canali in parallelo (DIP 3 settato in "ON")

Addr	Funzione	OUT	Addr	Funzione	OUT	Addr	Funzione	OUT
+0	Dim to warm	CH TUTTI	+0	Dim to warm	CH TUTTI	+0	Dim to warm	CH TUTTI

MAPPA: BIANCO DINAMICO



MAPPA	Funzione	
BIANCO DINAMICO	Dimmer	Dimmer (Valore Intensità) 0 .. 254
	CCT	Correzione della Temperatura Colore 0 ..254 (Valore 127 Bianco Neutro)

ASSEGNAZIONE INDIRIZZI IN BASE ALLA TIPOLOGIA DEL CARICO

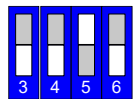
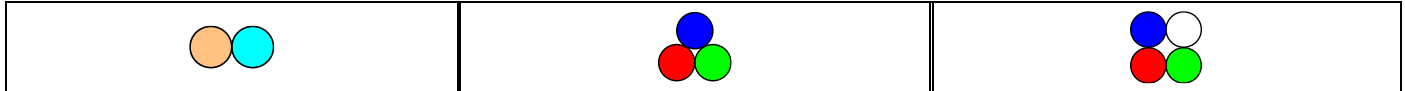

Gestione dei canali singolarmente (DIP 3 settato in "OFF")

Addr	Funzione	OUT	Addr	Funzione	OUT	Addr	Funzione	OUT
+0	Dimmer	CH 1-2	+0	Dimmer	CH 1-3	+0	Dimmer	CH 1-4
+1	CCT	CH 1-2	+1	CCT	CH 1-3	+1	CCT	CH 1-4
+2	Dimmer	CH 3-4	+2	Dimmer	CH 4-6	+2	Dimmer	CH 5-8
+3	CCT	CH 3-4	+3	CCT	CH 4-6	+3	CCT	CH 5-8
+4	Dimmer	CH 5-6	+4	Dimmer	CH 7-9	+4	Dimmer	CH 9-12
+5	CCT	CH 5-6	+5	CCT	CH 7-9	+5	CCT	CH 9-12
+6	Dimmer	CH 7-8	+6	Dimmer	CH 10-12			
+7	CCT	CH 7-8	+7	CCT	CH 10-12			
+8	Dimmer	CH 9-10						
+9	CCT	CH 9-10						
+10	Dimmer	CH 11-12						
+11	CCT	CH 11-12						

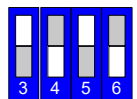

Gestione dei canali in parallelo (DIP 3 settato in "ON")

Addr	Funzione	OUT	Addr	Funzione	OUT	Addr	Funzione	OUT
+0	Dimmer	CH TUTTI	+0	Dimmer	CH TUTTI	+0	Dimmer	CH TUTTI
+1	CCT	CH TUTTI	+1	CCT	CH TUTTI	+1	CCT	CH TUTTI

MAPPA: SMART HSV



MAPPA	Funzione																															
Smart SHV	Master Dimmer	Master Dimmer (Valore Intensità) 0 .. 254																														
	Correzione Temp. Colore	Correzione della Temperatura Colore 0 .. 254																														
	Hue	Hue 0 .. 254																														
	Hue Rotation (rainbow) Time	Stop	0 .. 25	3s	26 .. 51	6s	52 .. 76	15s	77..102	30s	103..127	1'	128..153	3'	154..179	6'	180..204	15'	205..230	30'	231..254											
		Hue Fine	0 .. 15	Hold	16..25																											
	Saturazione	Saturazione 0 .. 254																														
	Strobo Rate	steady	0..15	blackout	16..31	1fps	32..47	2fps	48..63	3fps	64..79	4fps	80..95	5fps	96..111	6fps	112..127	7fps	128..143	8fps	144..159	9fps	160..175	10fps	176..191	12fps	192..207	14fps	208..223	16fps	224..239	steady

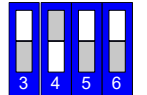
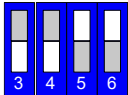

**ASSEGNAZIONE INDIRIZZI IN BASE ALLA TIPOLOGIA DEL CARICO**

Gestione dei canali singolarmente (DIP 3 settato in "OFF")					
RGB			RGBW		
Addr	Funzione	OUT	Addr	Funzione	OUT
+0	DIMMER	CH 1,2,3	+0	DIMMER	CH 1,2,3,4
+1	CCT	CH 1,2,3	+1	CCT	CH 1,2,3,4
+2	HUE	CH 1,2,3	+2	HUE	CH 1,2,3,4
+3	Rainbow	CH 1,2,3	+3	Rainbow	CH 1,2,3,4
+4	Saturazione	CH 1,2,3	+4	Saturazione	CH 1,2,3,4
+5	Strobo	CH 1,2,3	+5	Strobo	CH 1,2,3,4
+6	DIMMER	CH 4,5,6	+6	DIMMER	CH 5,6,7,8
+7	CCT	CH 4,5,6	+7	CCT	CH 5,6,7,8
+8	HUE	CH 4,5,6	+8	HUE	CH 5,6,7,8
+9	Rainbow	CH 4,5,6	+9	Rainbow	CH 5,6,7,8
+10	Saturazione	CH 4,5,6	+10	Saturazione	CH 5,6,7,8
+11	Strobo	CH 4,5,6	+11	Strobo	CH 5,6,7,8
+12	DIMMER	CH 7,8,9	+12	DIMMER	CH 9,10,11,12
+13	CCT	CH 7,8,9	+13	CCT	CH 9,10,11,12
+14	HUE	CH 7,8,9	+14	HUE	CH 9,10,11,12
+15	Rainbow	CH 7,8,9	+15	Rainbow	CH 9,10,11,12
+16	Saturazione	CH 7,8,9	+16	Saturazione	CH 9,10,11,12
+17	Strobo	CH 7,8,9	+17	Strobo	CH 9,10,11,12
+18	DIMMER	CH 10,11,12			
+19	CCT	CH 10,11,12			
+20	HUE	CH 10,11,12			
+21	Rainbow	CH 10,11,12			
+22	Saturazione	CH 10,11,12			
+23	Strobo	CH 10,11,12			

Gestione dei canali in parallelo (DIP 3 settato in "ON")					
RGB			RGBW		
Addr	Funzione	OUT	Addr	Funzione	OUT
+0	DIMMER	CH TUTTI	+0	DIMMER	CH TUTTI
+1	CCT	CH TUTTI	+1	CCT	CH TUTTI
+2	HUE	CH TUTTI	+2	HUE	CH TUTTI
+3	Rainbow	CH TUTTI	+3	Rainbow	CH TUTTI
+4	Saturazione	CH TUTTI	+4	Saturazione	CH TUTTI
+5	Strobo	CH TUTTI	+5	Strobo	CH TUTTI

**MAPPA: RGB**



MAPPA	Funzione	
RGB	R	Dimmer R (Valore Intensità) 0 .. 254
	G	Dimmer G (Valore Intensità) 0 .. 254
	B	Dimmer B (Valore Intensità) 0 .. 254

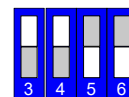
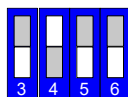

## ASSEGNAZIONE INDIRIZZI IN BASE ALLA TIPOLOGIA DEL CARICO

Gestione dei canali singolarmente (DIP 3 settato in "OFF")					
RGB			RGBW		
Addr	Funzione	OUT	Addr	Funzione	OUT
+0	R	CH 1	+0	R	CH 1
+1	G	CH 2	+1	G	CH 2
+2	B	CH 3	+2	B	CH 3
+3	R	CH 4	+3	R	CH 5
+4	G	CH 5	+4	G	CH 6
+5	B	CH 6	+5	B	CH 7
+6	R	CH 7	+6	R	CH 9
+7	G	CH 8	+7	G	CH 10
+8	B	CH 9	+8	B	CH 11
+9	R	CH 10			
+10	G	CH 11			
+11	B	CH 12			

Gestione dei canali in parallelo (DIP 3 settato in "ON")					
RGB			RGBW		
Addr	Funzione	OUT	Addr	Funzione	OUT
+0	R	CH 1,4,7,10	+0	R	CH 1,5,9
+1	G	CH 2,5,8,11	+1	G	CH 2,6,10
+2	B	CH 3,6,9,12	+2	B	CH 3,7,11

MAPPA: RGBW



MAPPA	Funzione	
RGBW	R	Dimmer R (Valore Intensità) 0 .. 254
	G	Dimmer G (Valore Intensità) 0 .. 254
	B	Dimmer B (Valore Intensità) 0 .. 254
	W	Dimmer W (Valore Intensità) 0 .. 254

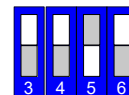
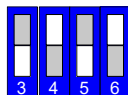

## ASSEGNAZIONE INDIRIZZI IN BASE ALLA TIPOLOGIA DEL CARICO

Gestione dei canali singolarmente (DIP 3 settato in "OFF")					
RGB			RGBW		
Addr	Funzione	OUT	Addr	Funzione	OUT
+0	R	CH 1	+0	R	CH 1
+1	G	CH 2	+1	G	CH 2
+2	B	CH 3	+2	B	CH 3
+3	W	CH 1-3	+3	W	CH 4
+4	R	CH 4	+4	R	CH 5
+5	G	CH 5	+5	G	CH 6
+6	B	CH 6	+6	B	CH 7
+7	W	CH 4-6	+7	W	CH 8
+8	R	CH 7	+8	R	CH 9
+9	G	CH 8	+9	G	CH 10
+10	B	CH 9	+10	B	CH 11
+11	W	CH 7-9	+11	W	CH 12
+12	R	CH 10			
+13	G	CH 11			
+14	B	CH 12			
+15	W	CH 10-12			

Gestione dei canali in parallelo (DIP 3 settato in "ON")					
RGB			RGBW		
Addr	Funzione	OUT	Addr	Funzione	OUT
+0	R	CH 1,4,7,10	+0	R	CH 1,5,9
+1	G	CH 2,5,8,11	+1	G	CH 2,6,10
+2	B	CH 3,6,9,12	+2	B	CH 3,7,11
+3	W	CH TUTTI	+3	W	CH TUTTI

MAPPA: MRGB+



MAPPA	Funzione	
MRGB+	Master Dimmer	Master Dimmer (Valore Intensità) 0 .. 254
	R	Dimmer R (Valore Intensità) 0 .. 254
	G	Dimmer G (Valore Intensità) 0 .. 254
	B	Dimmer B (Valore Intensità) 0 .. 254
	Strobo Rate	steady 0..15   blackout 16..31   1fps 32..47   2fps 48..63   3fps 64..79   4fps 80..95   5fps 96..111   6fps 112..127   7fps 128..143   8fps 144..159   9fps 160..175   10fps 176..191   12fps 192..207   14fps 208..223   16fps 224..239   steady 240..254

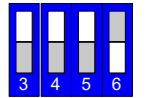
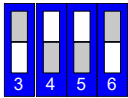

**ASSEGNAZIONE INDIRIZZI IN BASE ALLA TIPOLOGIA DEL CARICO**

Gestione dei canali singolarmente (DIP 3 settato in "OFF")					
RGB			RGBW		
Addr	Funzione	OUT	Addr	Funzione	OUT
+0	MASTER DIMMER	CH 1-3	+0	MASTER DIMMER	CH 1-3
+1	R	CH 1	+1	R	CH 1
+2	G	CH 2	+2	G	CH 2
+3	B	CH 3	+3	B	CH 3
+4	STROBO RATE	CH 1-3	+4	STROBO RATE	CH 1-3
+5	MASTER DIMMER	CH 4-6	+5	MASTER DIMMER	CH 5-7
+6	R	CH 4	+6	R	CH 5
+7	G	CH 5	+7	G	CH 6
+8	B	CH 6	+8	B	CH 7
+9	STROBO RATE	CH 4-6	+9	STROBO RATE	CH 5-7
+10	MASTER DIMMER	CH 7-9	+10	MASTER DIMMER	CH 9-11
+11	R	CH 7	+11	R	CH 9
+12	G	CH 8	+12	G	CH 10
+13	B	CH 9	+13	B	CH 11
+14	STROBO RATE	CH 7-9	+14	STROBO RATE	CH 9-11
+15	MASTER DIMMER	CH 10-12			
+16	R	CH 10			
+17	G	CH 11			
+18	B	CH 12			
+19	STROBO RATE	CH 10-12			

Gestione dei canali in parallelo (DIP 3 settato in "ON")					
RGB			RGBW		
Addr	Funzione	OUT	Addr	Funzione	OUT
+0	MASTER DIMMER	CH TUTTI	+0	MASTER DIMMER	CH 1,2,3,5,6,7,9,10,11
+1	R	CH 1,4,7,10	+1	R	CH 1,5,9
+2	G	CH 2,5,8,11	+2	G	CH 2,6,10
+3	B	CH 3,6,9,12	+3	B	CH 3,7,11
+4	STROBO RATE	CH TUTTI	+4	STROBO RATE	CH TUTTI

MAPPA: MRGBW+



MAPPA	Funzione																																
MRGBW+	Master Dimmer	Master Dimmer (Valore Intensità) 0 .. 254																															
	R	Dimmer R (Valore Intensità) 0 .. 254																															
	G	Dimmer G (Valore Intensità) 0 .. 254																															
	B	Dimmer B (Valore Intensità) 0 .. 254																															
	W	Dimmer W (Valore Intensità) 0 .. 254																															
	Strobo Rate	0 .. 254																															
		<table border="1"> <tr> <td>steady</td><td>blackout</td><td>1fps</td><td>2fps</td><td>3fps</td><td>4fps</td><td>5fps</td><td>6fps</td><td>7fps</td><td>8fps</td><td>9fps</td><td>10fps</td><td>12fps</td><td>14fps</td><td>16fps</td><td>steady</td> </tr> <tr> <td>0..15</td><td>16..31</td><td>32..47</td><td>48..63</td><td>64..79</td><td>80..95</td><td>96..111</td><td>112..127</td><td>128..143</td><td>144..159</td><td>160..175</td><td>176..191</td><td>192..207</td><td>208..223</td><td>224..239</td><td>240..254</td> </tr> </table>	steady	blackout	1fps	2fps	3fps	4fps	5fps	6fps	7fps	8fps	9fps	10fps	12fps	14fps	16fps	steady	0..15	16..31	32..47	48..63	64..79	80..95	96..111	112..127	128..143	144..159	160..175	176..191	192..207	208..223	224..239
steady	blackout	1fps	2fps	3fps	4fps	5fps	6fps	7fps	8fps	9fps	10fps	12fps	14fps	16fps	steady																		
0..15	16..31	32..47	48..63	64..79	80..95	96..111	112..127	128..143	144..159	160..175	176..191	192..207	208..223	224..239	240..254																		

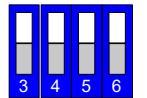
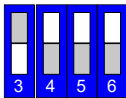

**ASSEGNAZIONE INDIRIZZI IN BASE ALLA TIPOLOGIA DEL CARICO**

Gestione dei canali singolarmente (DIP 3 settato in "OFF")					
RGB			RGBW		
Addr	Funzione	OUT	Addr	Funzione	OUT
+0	MASTER DIMMER	CH 1-3	+0	MASTER DIMMER	CH 1-4
+1	R	CH 1	+1	R	CH 1
+2	G	CH 2	+2	G	CH 2
+3	B	CH 3	+3	B	CH 3
+4	W	CH 1-3	+4	W	CH 4
+5	STROBO RATE	CH 1-3	+5	STROBO RATE	CH 1-4
+6	MASTER DIMMER	CH 4-6	+6	MASTER DIMMER	CH 5-8
+7	R	CH 4	+7	R	CH 5
+8	G	CH 5	+8	G	CH 6
+9	B	CH 6	+9	B	CH 7
+10	W	CH 4-6	+10	W	CH 8
+11	STROBO RATE	CH 4-6	+11	STROBO RATE	CH 5-8
+12	MASTER DIMMER	CH 7-9	+12	MASTER DIMMER	CH 9-12
+13	R	CH 7	+13	R	CH 9
+14	G	CH 8	+14	G	CH 10
+15	B	CH 9	+15	B	CH 11
+16	W	CH 7-9	+16	W	CH 12
+17	STROBO RATE	CH 7-9	+17	STROBO RATE	CH 9-12
+18	MASTER DIMMER	CH 10-12			
+19	R	CH 10			
+20	G	CH 11			
+21	B	CH 12			
+22	W	CH 10-12			
+23	STROBO RATE	CH 10-12			

Gestione dei canali in parallelo (DIP 3 settato in "ON")					
RGB			RGBW		
Addr	Funzione	OUT	Addr	Funzione	OUT
+0	MASTER DIMMER	CH TUTTI	+0	MASTER DIMMER	CH TUTTI
+1	R	CH 1,4,7,10	+1	R	CH 1,5,9
+2	G	CH 2,5,8,11	+2	G	CH 2,6,10
+3	B	CH 3,6,9,12	+3	B	CH 3,7,11
+4	W	CH TUTTI	+4	W	CH 4,8,9
+5	STROBO RATE	CH TUTTI	+5	STROBO RATE	CH TUTTI

➤ **COMANDI DALI**







Con la modalità **BUS DMX+RDM "slave"** le uscite vengono gestite tramite un controllo **DMX esterno**.  
Con la modalità **"master"** il dispositivo diventa un **controller DMX** e pilota altri dispositivi **DMX**.

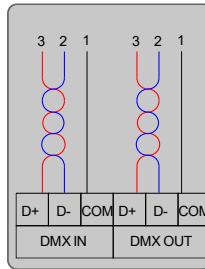
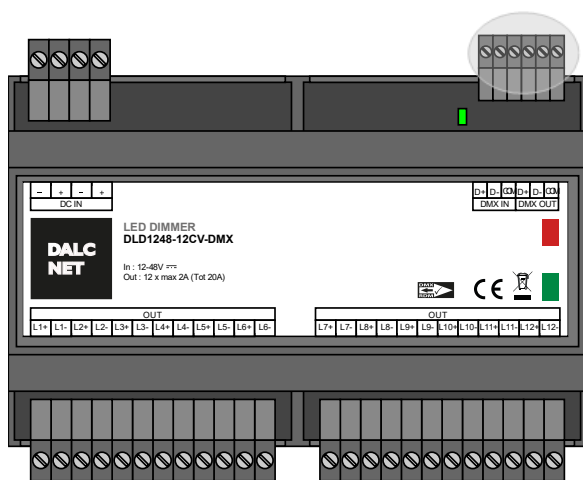

Use	3-Pin XLR Pin #	DMX512 Function
Common Reference	1	Data Link Common
Primary Data Link	2	Data 1-
	3	Data 1+
Secondary Data Link (Optional – see clause 4.8)	4	Data 2-
	5	Data 2+

**Caratteristiche**

- BUS DMX512-A +RDM

**Norme di riferimento relative al BUS DMX+RDM**

ANSI E1.11	Entertainment Technology – USITT DMX512-A – Asynchronous Serial Digital Data Transmission Standard for Controlling Lighting Equipment and Accessories
ANSI E1.20	Entertainment Technology-RDM-Remote Device Management over USITT DMX512 Networks

**Specifiche Tecniche**

Standard DMX512-A+RDM

Led di segnalazione:

- Nel caso vi sia un errore del BUS il Led di segnalazione lampeggia velocemente (2 impulsi al secondo).
- Nel caso il BUS non venga rilevato correttamente il Led di segnalazione lampeggia lentamente (1 impulso al secondo).
- Nel caso vi sia il segnale del BUS connesso e correttamente funzionante il Led rimane acceso fisso.

Indirizzamento:

RDM	✓
Tramite i selettori	✓

DMX	000 (Default)	BCDEF0123456789A	BCDEF0123456789A	BCDEF0123456789A		Indirizzo impostato dal protocollo RDM
Da 001	BCDEF0123456789A	BCDEF0123456789A	BCDEF0123456789A	A	BCDEF0123456789A	Indirizzamento DMX Da 1 a 512

MAPPA INDIRIZZI – DMX512

MAPPA: DIMMER

MAPPA	Funzione	
DIMMER	Dimmer	Dimmer (Valore Intensità) 0 .. 255

ASSEGNAZIONE INDIRIZZI IN BASE ALLA TIPOLOGIA DEL CARICO: Bianco, Bianco Dinamico, RGB e RGBW

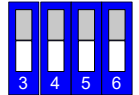

Gestione dei canali singolarmente (DIP 3 settato in "OFF")

Ch	Funzione	OUT	Ch	Funzione	OUT	Ch	Funzione	OUT	Ch	Funzione	OUT
1	Dimmer	CH 1	1	Dimmer	CH 1-2	1	Dimmer	CH 1-3	1	Dimmer	CH 1-4
2	Dimmer	CH 2	2	Dimmer	CH 3-4	2	Dimmer	CH 4-6	2	Dimmer	CH 5-8
3	Dimmer	CH 3	3	Dimmer	CH 5-6	3	Dimmer	CH 7-9	3	Dimmer	CH 9-12
4	Dimmer	CH 4	4	Dimmer	CH 7-8	4	Dimmer	CH 10-12			
5	Dimmer	CH 5	5	Dimmer	CH 9-10						
6	Dimmer	CH 6	6	Dimmer	CH 11-12						
7	Dimmer	CH 7									
8	Dimmer	CH 8									
9	Dimmer	CH 9									
10	Dimmer	CH 10									
11	Dimmer	CH 11									
12	Dimmer	CH 12									

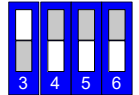

Gestione dei canali in parallelo (DIP 3 settato in "ON")

Ch	Funzione	OUT	Ch	Funzione	OUT	Ch	Funzione	OUT	Ch	Funzione	OUT
1	Dimmer	CH TUTTI	1	Dimmer	CH TUTTI	1	Dimmer	CH TUTTI	1	Dimmer	CH 4,8,12

MAPPA: DIM TO WARM



MAPPA	Funzione	
DIM TO WARM	Dim to warm	Dimmer (Valore Intensità) 0 .. 255

ASSEGNAZIONE INDIRIZZI IN BASE ALLA TIPOLOGIA DEL CARICO

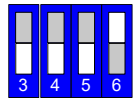
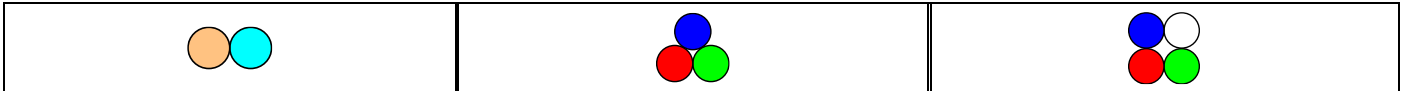

Gestione dei canali singolarmente (DIP 3 settato in "OFF")

Ch	Funzione	OUT	Ch	Funzione	OUT	Ch	Funzione	OUT
1	Dim to warm	CH 1-2	1	Dim to warm	CH 1,2,3	1	Dim to warm	CH 1,2,3,4
2	Dim to warm	CH 3-4	2	Dim to warm	CH 4,5,6	2	Dim to warm	CH 5,6,7,8
3	Dim to warm	CH 5-6	3	Dim to warm	CH 7,8,9	3	Dim to warm	CH 9,10,11,12
4	Dim to warm	CH 7-8	4	Dim to warm	CH 10,11,12			
5	Dim to warm	CH 9-10						
6	Dim to warm	CH 11-12						

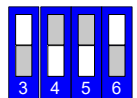



Gestione dei canali in parallelo (DIP 3 settato in "ON")

Ch	Funzione	OUT	Ch	Funzione	OUT	Ch	Funzione	OUT
1	Dim to warm	CH TUTTI	1	Dim to warm	CH TUTTI	1	Dim to warm	CH TUTTI

MAPPA: BIANCO DINAMICO

MAPPA	Funzione	
BIANCO DINAMICO	Dimmer	Dimmer (Valore Intensità) 0 .. 255
	CCT	Correzione della Temperatura Colore 0 ..255 (Valore 127 Bianco Neutro)

## ASSEGNAZIONE INDIRIZZI IN BASE ALLA TIPOLOGIA DEL CARICO

		
---	---	---

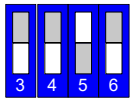

## Gestione dei canali singolarmente (DIP 3 settato in "OFF")

Ch	Funzione	OUT	Ch	Funzione	OUT	Ch	Funzione	OUT
1	Dimmer	CH 1-2	1	Dimmer	CH 1-3	1	Dimmer	CH 1-4
2	CCT	CH 1-2	2	CCT	CH 1-3	2	CCT	CH 1-4
3	Dimmer	CH 3-4	3	Dimmer	CH 4-6	3	Dimmer	CH 5-8
4	CCT	CH 3-4	4	CCT	CH 4-6	4	CCT	CH 5-8
5	Dimmer	CH 5-6	5	Dimmer	CH 7-9	5	Dimmer	CH 9-12
6	CCT	CH 5-6	6	CCT	CH 7-9	6	CCT	CH 9-12
7	Dimmer	CH 7-8	7	Dimmer	CH 10-12			
8	CCT	CH 7-8	8	CCT	CH 10-12			
9	Dimmer	CH 9-10						
10	CCT	CH 9-10						
11	Dimmer	CH 11-12						
12	CCT	CH 11-12						

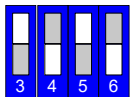

## Gestione dei canali in parallelo (DIP 3 settato in "ON")

Ch	Funzione	OUT	Ch	Funzione	OUT	Ch	Funzione	OUT
1	Dimmer	CH TUTTI	1	Dimmer	CH TUTTI	1	Dimmer	CH TUTTI
2	CCT	CH TUTTI	2	CCT	CH TUTTI	2	CCT	CH TUTTI

MAPPA: SMART HSV

MAPPA	Funzione																				
Smart SHV	Master Dimmer	Master Dimmer (Valore Intensità) 0 .. 255																			
	Correzione Temp. Colore	Correzione della Temperatura Colore 0 .. 255																			
	Hue	Hue 0 .. 255																			
	Hue Rotation (rainbow) Time	Stop	0 .. 25	3s		6s		15s		30s		1'		3'		6'		15'		30'	
		Hue Fine	0 .. 15	Hold																	
	Saturazione	Saturazione 0 .. 255																			
Strobo Rate	steady	blackout	1fps	2fps	3fps	4fps	5fps	6fps	7fps	8fps	9fps	10fps	12fps	14fps	16fps	steady					
	0..15	16..31	32..47	48..63	64..79	80..95	96..111	112..127	128..143	144..159	160..175	176..191	192..207	208..223	224..239	240..254					

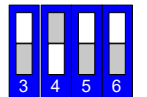
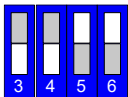

ASSEGNAZIONE INDIRIZZI IN BASE ALLA TIPOLOGIA DEL CARICO

Gestione dei canali singolarmente (DIP 3 settato in "OFF")			Gestione dei canali in parallelo (DIP 3 settato in "ON")		
RGB			RGBW		
Ch	Funzione	OUT	Ch	Funzione	OUT
1	DIMMER	CH 1,2,3	1	DIMMER	CH 1,2,3,4
2	CCT	CH 1,2,3	2	CCT	CH 1,2,3,4
3	HUE	CH 1,2,3	3	HUE	CH 1,2,3,4
4	Rainbow	CH 1,2,3	4	Rainbow	CH 1,2,3,4
5	Saturazione	CH 1,2,3	5	Saturazione	CH 1,2,3,4
6	Strobo	CH 1,2,3	6	Strobo	CH 1,2,3,4
7	DIMMER	CH 4,5,6	7	DIMMER	CH 5,6,7,8
8	CCT	CH 4,5,6	8	CCT	CH 5,6,7,8
9	HUE	CH 4,5,6	9	HUE	CH 5,6,7,8
10	Rainbow	CH 4,5,6	10	Rainbow	CH 5,6,7,8
11	Saturazione	CH 4,5,6	11	Saturazione	CH 5,6,7,8
12	Strobo	CH 4,5,6	12	Strobo	CH 5,6,7,8
13	DIMMER	CH 7,8,9	13	DIMMER	CH 9,10,11,12
14	CCT	CH 7,8,9	14	CCT	CH 9,10,11,12
15	HUE	CH 7,8,9	15	HUE	CH 9,10,11,12
16	Rainbow	CH 7,8,9	16	Rainbow	CH 9,10,11,12
17	Saturazione	CH 7,8,9	17	Saturazione	CH 9,10,11,12
18	Strobo	CH 7,8,9	18	Strobo	CH 9,10,11,12
19	DIMMER	CH 10,11,12			
20	CCT	CH 10,11,12			
21	HUE	CH 10,11,12			
22	Rainbow	CH 10,11,12			
23	Saturazione	CH 10,11,12			
24	Strobo	CH 10,11,12			

Gestione dei canali in parallelo (DIP 3 settato in "ON")			Gestione dei canali in parallelo (DIP 3 settato in "ON")		
RGB			RGBW		
Ch	Funzione	OUT	Ch	Funzione	OUT
1	DIMMER	CH TUTTI	1	DIMMER	CH TUTTI
2	CCT	CH TUTTI	2	CCT	CH TUTTI
3	HUE	CH TUTTI	3	HUE	CH TUTTI
4	Rainbow	CH TUTTI	4	Rainbow	CH TUTTI
5	Saturazione	CH TUTTI	5	Saturazione	CH TUTTI
6	Strobo	CH TUTTI	6	Strobo	CH TUTTI

MAPPA: RGB



MAPPA	Funzione	
RGB	R	Dimmer R (Valore Intensità) 0 .. 255
	G	Dimmer G (Valore Intensità) 0 .. 255
	B	Dimmer B (Valore Intensità) 0 .. 255

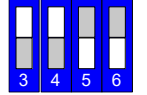
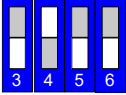

ASSEGNAZIONE INDIRIZZI IN BASE ALLA TIPOLOGIA DEL CARICO

Gestione dei canali singolarmente (DIP 3 settato in "OFF")					
RGB			RGBW		
Ch	Funzione	OUT	Ch	Funzione	OUT
1	R	CH 1	1	R	CH 1
2	G	CH 2	2	G	CH 2
3	B	CH 3	3	B	CH 3
4	R	CH 4	4	R	CH 5
5	G	CH 5	5	G	CH 6
6	B	CH 6	6	B	CH 7
7	R	CH 7	7	R	CH 9
8	G	CH 8	8	G	CH 10
9	B	CH 9	9	B	CH 11
10	R	CH 10			
11	G	CH 11			
12	B	CH 12			

Gestione dei canali in parallelo (DIP 3 settato in "ON")					
RGB			RGBW		
Ch	Funzione	OUT	Ch	Funzione	OUT
1	R	CH 1,4,7,10	1	R	CH 1,5,9
2	G	CH 2,5,8,11	2	G	CH 2,6,10
3	B	CH 3,6,9,12	3	B	CH 3,7,11

MAPPA: RGBW



MAPPA	Funzione	
RGBW	R	Dimmer R (Valore Intensità) 0 .. 255
	G	Dimmer G (Valore Intensità) 0 .. 255
	B	Dimmer B (Valore Intensità) 0 .. 255
	W	Dimmer W (Valore Intensità) 0 .. 255

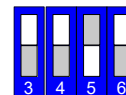
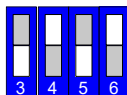

ASSEGNAZIONE INDIRIZZI IN BASE ALLA TIPOLOGIA DEL CARICO

Gestione dei canali singolarmente (DIP 3 settato in "OFF")					
RGB			RGBW		
Ch	Funzione	OUT	Ch	Funzione	OUT
1	R	CH 1	1	R	CH 1
2	G	CH 2	2	G	CH 2
3	B	CH 3	3	B	CH 3
4	W	CH 1-3	4	W	CH 4
5	R	CH 4	5	R	CH 5
6	G	CH 5	6	G	CH 6
7	B	CH 6	7	B	CH 7
8	W	CH 4-6	8	W	CH 8
9	R	CH 7	9	R	CH 9
10	G	CH 8	10	G	CH 10
11	B	CH 9	11	B	CH 11
12	W	CH 7-9	12	W	CH 12
13	R	CH 10			
14	G	CH 11			
15	B	CH 12			
16	W	CH 10-12			

Gestione dei canali in parallelo (DIP 3 settato in "ON")					
RGB			RGBW		
Ch	Funzione	OUT	Ch	Funzione	OUT
1	R	CH 1,4,7,10	1	R	CH 1,5,9
2	G	CH 2,5,8,11	2	G	CH 2,6,10
3	B	CH 3,6,9,12	3	B	CH 3,7,11
4	W	CH TUTTI	4	W	CH TUTTI

MAPPA: MRGB+





MAPPA	Funzione																																
MRGB+	Master Dimmer	Master Dimmer (Valore Intensità) 0 .. 255																															
	R	Dimmer R (Valore Intensità) 0 .. 255																															
	G	Dimmer G (Valore Intensità) 0 .. 255																															
	B	Dimmer B (Valore Intensità) 0 .. 255																															
	Strobo Rate	<table border="1"> <tr> <td>steady</td><td>blackout</td><td>1fps</td><td>2fps</td><td>3fps</td><td>4fps</td><td>5fps</td><td>6fps</td><td>7fps</td><td>8fps</td><td>9fps</td><td>10fps</td><td>12fps</td><td>14fps</td><td>16fps</td><td>steady</td> </tr> <tr> <td>0..15</td><td>16..31</td><td>32..47</td><td>48..63</td><td>64..79</td><td>80..95</td><td>96..111</td><td>112..127</td><td>128..143</td><td>144..159</td><td>160..175</td><td>176..191</td><td>192..207</td><td>208..223</td><td>224..239</td><td>240..254</td> </tr> </table>	steady	blackout	1fps	2fps	3fps	4fps	5fps	6fps	7fps	8fps	9fps	10fps	12fps	14fps	16fps	steady	0..15	16..31	32..47	48..63	64..79	80..95	96..111	112..127	128..143	144..159	160..175	176..191	192..207	208..223	224..239
steady	blackout	1fps	2fps	3fps	4fps	5fps	6fps	7fps	8fps	9fps	10fps	12fps	14fps	16fps	steady																		
0..15	16..31	32..47	48..63	64..79	80..95	96..111	112..127	128..143	144..159	160..175	176..191	192..207	208..223	224..239	240..254																		

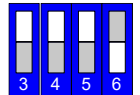
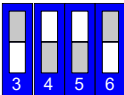

**ASSEGNAZIONE INDIRIZZI IN BASE ALLA TIPOLOGIA DEL CARICO**

Gestione dei canali singolarmente (DIP 3 settato in "OFF")					
RGB			RGBW		
Ch	Funzione	OUT	Ch	Funzione	OUT
1	MASTER DIMMER	CH 1-3	1	MASTER DIMMER	CH 1-3
2	R	CH 1	2	R	CH 1
3	G	CH 2	3	G	CH 2
4	B	CH 3	4	B	CH 3
5	STROBO RATE	CH 1-3	5	STROBO RATE	CH 1-3
6	MASTER DIMMER	CH 4-6	6	MASTER DIMMER	CH 5-7
7	R	CH 4	7	R	CH 5
8	G	CH 5	8	G	CH 6
9	B	CH 6	9	B	CH 7
10	STROBO RATE	CH 4-6	10	STROBO RATE	CH 5-7
11	MASTER DIMMER	CH 7-9	11	MASTER DIMMER	CH 9-11
12	R	CH 7	12	R	CH 9
13	G	CH 8	13	G	CH 10
14	B	CH 9	14	B	CH 11
15	STROBO RATE	CH 7-9	15	STROBO RATE	CH 9-11
16	MASTER DIMMER	CH 10-12			
17	R	CH 10			
18	G	CH 11			
19	B	CH 12			
20	STROBO RATE	CH 10-12			

Gestione dei canali in parallelo (DIP 3 settato in "ON")					
RGB			RGBW		
Ch	Funzione	OUT	Ch	Funzione	OUT
1	MASTER DIMMER	CH TUTTI	1	MASTER DIMMER	CH 1,2,3,5,6,7,9,10,11
2	R	CH 1,4,7,10	2	R	CH 1,5,9
3	G	CH 2,5,8,11	3	G	CH 2,6,10
4	B	CH 3,6,9,12	4	B	CH 3,7,11
5	STROBO RATE	CH TUTTI	5	STROBO RATE	CH TUTTI

MAPPA: MRGBW+



MAPPA	Funzione																																
MRGBW+	Master Dimmer	Master Dimmer (Valore Intensità) 0 .. 255																															
	R	Dimmer R (Valore Intensità) 0 .. 255																															
	G	Dimmer G (Valore Intensità) 0 .. 255																															
	B	Dimmer B (Valore Intensità) 0 .. 255																															
	W	Dimmer W (Valore Intensità) 0 .. 255																															
	Strobo Rate	0 .. 255																															
		<table border="1"> <tr> <td>steady</td><td>blackout</td><td>1fps</td><td>2fps</td><td>3fps</td><td>4fps</td><td>5fps</td><td>6fps</td><td>7fps</td><td>8fps</td><td>9fps</td><td>10fps</td><td>12fps</td><td>14fps</td><td>16fps</td><td>steady</td> </tr> <tr> <td>0..15</td><td>16..31</td><td>32..47</td><td>48..63</td><td>64..79</td><td>80..95</td><td>96..111</td><td>112..127</td><td>128..143</td><td>144..159</td><td>160..175</td><td>176..191</td><td>192..207</td><td>208..223</td><td>224..239</td><td>240..254</td> </tr> </table>	steady	blackout	1fps	2fps	3fps	4fps	5fps	6fps	7fps	8fps	9fps	10fps	12fps	14fps	16fps	steady	0..15	16..31	32..47	48..63	64..79	80..95	96..111	112..127	128..143	144..159	160..175	176..191	192..207	208..223	224..239
steady	blackout	1fps	2fps	3fps	4fps	5fps	6fps	7fps	8fps	9fps	10fps	12fps	14fps	16fps	steady																		
0..15	16..31	32..47	48..63	64..79	80..95	96..111	112..127	128..143	144..159	160..175	176..191	192..207	208..223	224..239	240..254																		

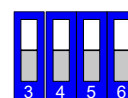
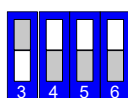

ASSEGNAZIONE INDIRIZZI IN BASE ALLA TIPOLOGIA DEL CARICO

Gestione dei canali singolarmente (DIP 3 settato in "OFF")					
RGB			RGBW		
Ch	Funzione	OUT	Ch	Funzione	OUT
1	MASTER DIMMER	CH 1-3	1	MASTER DIMMER	CH 1-4
2	R	CH 1	2	R	CH 1
3	G	CH 2	3	G	CH 2
4	B	CH 3	4	B	CH 3
5	W	CH 1-3	5	W	CH 4
6	STROBO RATE	CH 1-3	6	STROBO RATE	CH 1-4
7	MASTER DIMMER	CH 4-6	7	MASTER DIMMER	CH 5-8
8	R	CH 4	8	R	CH 5
9	G	CH 5	9	G	CH 6
10	B	CH 6	10	B	CH 7
11	W	CH 4-6	11	W	CH 8
12	STROBO RATE	CH 4-6	12	STROBO RATE	CH 5-8
13	MASTER DIMMER	CH 7-9	13	MASTER DIMMER	CH 9-12
14	R	CH 7	14	R	CH 9
15	G	CH 8	15	G	CH 10
16	B	CH 9	16	B	CH 11
17	W	CH 7-9	17	W	CH 12
18	STROBO RATE	CH 7-9	18	STROBO RATE	CH 9-12
19	MASTER DIMMER	CH 10-12			
20	R	CH 10			
21	G	CH 11			
22	B	CH 12			
23	W	CH 10-12			
24	STROBO RATE	CH 10-12			

Gestione dei canali in parallelo (DIP 3 settato in "ON")					
RGB			RGBW		
Ch	Funzione	OUT	Ch	Funzione	OUT
1	MASTER DIMMER	CH TUTTI	1	MASTER DIMMER	CH TUTTI
2	R	CH 1,4,7,10	2	R	CH 1,5,9
3	G	CH 2,5,8,11	3	G	CH 2,6,10
4	B	CH 3,6,9,12	4	B	CH 3,7,11
5	W	CH TUTTI	5	W	CH 4,8,9
6	STROBO RATE	CH TUTTI	6	STROBO RATE	CH TUTTI

➤ **COMANDI RDM**



PARAMETRI NECESSARI	
DISC_UNIQUE_BRANCH	✓
DISC_MUTE	✓
DISC_UN_MUTE	✓
SUPPORTED_PARAMETERS	✓
PARAMETERS_DESCRIPTION	✓
DEVICE_INFO	✓
SOFTWARE_VERSION_LABEL	✓
DMX_START_ADDRESS	✓
IDENTIFY_DEVICE	✓

PARAMETRI SUPPORTATI	
PRODUCT_DETAIL_ID_LIST	✓
DEVICE_MODEL_DESCRIPTION	✓
MANUFACTURER_LABEL	✓
DEVIDE_LABEL	✓
BOOT_SOFTWARE_VERSION_ID	✓
BOOT_SOFTWARE_VERSION_LABEL	✓
DMX_PERSONALITY	✓
DMX_PERSONALITY_DESCRIPTION	✓
SLOT_INFO	✓
SLOT_DESCRIPTION	✓
DEFAULT_SLOT_VALUE	✓

➤ **FADE UP / FADE DOWN:**

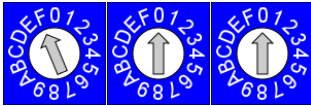
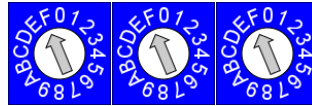
da  
F00a  
FFF

MASTER con Fade:

Selettore "x10" = Tempo di Fade UP  
Selettore "x1" = Tempo di Fade DOWN

0 = no Fade, F=60 secondi (vedi tabella)

Tempo di Fade:

0	1	2	3	4	5	6	7	8	9	A	B	C	D	E	F
NO fade	0.5s	1s	2s	3s	4s	5s	6s	7s	8s	9s	10s	15s	20s	30s	60s

Esempio:

Accensione e spegnimento senza Tempo di Fade (no Fade UP/DOWN): F00

Accensione senza Tempo di Fade (no Fade UP) e spegnimento con un Tempo di Fade di 5 secondi (fade DOWN): F06

Accensione con un Tempo di Fade di 1 secondo (Fade UP) e spegnimento con Tempo di Fade di 10 secondi (Fade DOWN): F2B

Nota:

Questa funzione è disponibile con le mappe: "Dimmer", "Dim to Warm", "Bianco Dinamico", "Smart HSV"

➤ **FUNZIONAMENTO TRAMITE MODBUS**

Con la modalità **MODBUS "slave"** lo stato delle luci a LED viene gestito tramite un controller esterno MODBUS RTU "master" (RS-458)

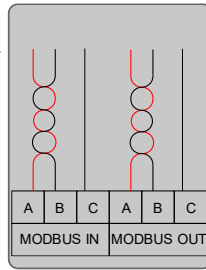
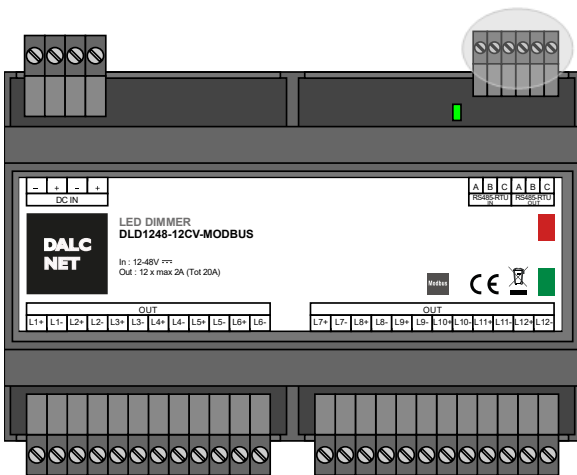

**Caratteristiche**

- BUS MODBUS RTU SLAVE su RS485

Normative di riferimento relative al BUS MODBUS

-	MODBUS APPLICATION PROTOCOL SPECIFICATION V1.1b
---	---

**Note:**

Il dispositivo non polarizza e non vi è implementata la possibilità di polarizzare il BUS. In questo caso la polarizzazione del BUS può essere implementata esternamente. La polarizzazione del BUS può essere effettuata dal Master Modbus o sui morsetti del dispositivo in ingresso del BUS. Se la polarizzazione del BUS viene effettuata dal Master o sui morsetti del dispositivo nessun dispositivo presente sul BUS deve implementare alcuna polarizzazione.

Per altre informazioni consultare la specifica MODBUS **"MODBUS over serial line specification and implementation guide V1.02"**.





Led di segnalazione:

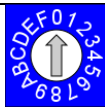
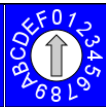
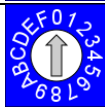

Nel caso vi sia un errore nel BUS il Led di segnalazione lampeggia velocemente (2 impulsi al secondo).

Nel caso il BUS non venga rilevato correttamente il Led di segnalazione lampeggia lentamente (1 impulso al secondo).

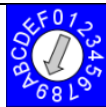
Nel caso vi sia il segnale del BUS connesso e correttamente funzionante il led rimane acceso fisso.

Indirizzamento tramite selettori:

Selettori x10, x1 (selettore centrale e destro)					
Modbus	00 (Default)				Default modbus ID (1)
	from 01			to 99	 

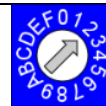
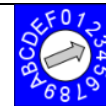
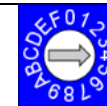
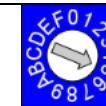
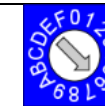
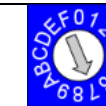
Selettore x100 (selettore sinistro)								
Modbus								
	0 115200 baud 8N1	1 115200 baud 8E1	2 38400 baud 8N1	3 38400 baud 8E1	4 19200 baud 8N1	5 19200 baud 8E1	6 9600 baud 8N1	7 9600 baud 8E1

MAPPA INDIRIZZI – DMX512

## MAPPA: DIMMER

MAPPA	Funzione	
DIMMER	Dimmer	Dimmer (Valore Intensità) 0 .. 255

## ASSEGNAZIONE INDIRIZZI IN BASE ALLA TIPOLOGIA DEL CARICO: Bianco, Bianco Dinamico, RGB e RGBW

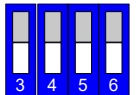

## Gestione dei canali singolarmente (DIP 3 settato in "OFF")

Var	Funzione	OUT	Var	Fuanzione	OUT	Var	Funzione	OUT	Var	Funzione	OUT
0	Dimmer	CH 1	0	Dimmer	CH 1-2	0	Dimmer	CH 1-3	0	Dimmer	CH 1-4
1	Dimmer	CH 2	1	Dimmer	CH 3-4	1	Dimmer	CH 4-6	1	Dimmer	CH 5-8
2	Dimmer	CH 3	2	Dimmer	CH 5-6	2	Dimmer	CH 7-9	2	Dimmer	CH 9-12
3	Dimmer	CH 4	3	Dimmer	CH 7-8	3	Dimmer	CH 10-12			
4	Dimmer	CH 5	4	Dimmer	CH 9-10						
5	Dimmer	CH 6	5	Dimmer	CH 11-12						
6	Dimmer	CH 7									
7	Dimmer	CH 8									
8	Dimmer	CH 9									
9	Dimmer	CH 10									
10	Dimmer	CH 11									
11	Dimmer	CH 12									

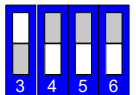

## Gestione dei canali in parallelo (DIP 3 settato in "ON")

Var	Funzione	OUT	Var	Funzione	OUT	Var	Funzione	OUT	Var	Funzione	OUT
0	Dimmer	CH TUTTI	0	Dimmer	CH TUTTI	0	Dimmer	CH TUTTI	0	Dimmer	CH 4,8,12

## MAPPA: DIM TO WARM



MAPPA	Funzione	
DIM TO WARM	Dim to warm	Dimmer (Valore Intensità) 0 .. 255

ASSEGNAZIONE INDIRIZZI IN BASE ALLA TIPOLOGIA DEL CARICO

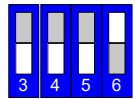
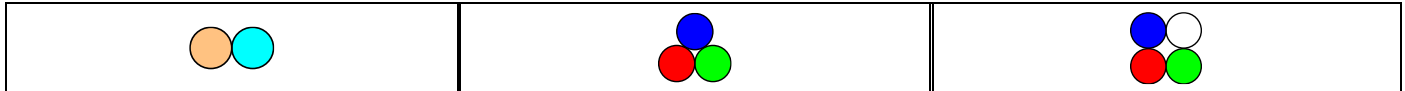

Gestione dei canali singolarmente (DIP 3 settato in "OFF")

Var	Funzione	OUT	Var	Funzione	OUT	Var	Funzione	OUT
0	Dim to warm	CH 1-2	0	Dim to warm	CH 1,2,3	0	Dim to warm	CH 1,2,3,4
1	Dim to warm	CH 3-4	1	Dim to warm	CH 4,5,6	1	Dim to warm	CH 5,6,7,8
2	Dim to warm	CH 5-6	2	Dim to warm	CH 7,8,9	2	Dim to warm	CH 9,10,11,12
3	Dim to warm	CH 7-8	3	Dim to warm	CH 10,11,12			
4	Dim to warm	CH 9-10						
5	Dim to warm	CH 11-12						

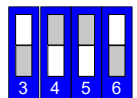

Gestione dei canali in parallelo (DIP 3 settato in "ON")

Var	Funzione	OUT	Var	Funzione	OUT	Var	Funzione	OUT
0	Dim to warm	CH TUTTI	0	Dim to warm	CH TUTTI	0	Dim to warm	CH TUTTI

MAPPA: BIANCO DINAMICO



MAPPA	Funzione	
BIANCO DINAMICO	Dimmer	Dimmer (Valore Intensità) 0 .. 255
	CCT	Correzione della Temperatura Colore 0 ..255 (Valore 127 Bianco Neutro)

ASSEGNAZIONE INDIRIZZI IN BASE ALLA TIPOLOGIA DEL CARICO

--	--	--

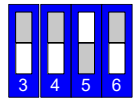

Gestione dei canali singolarmente (DIP 3 settato in "OFF")

Var	Funzione	OUT	Var	Funzione	OUT	Var	Funzione	OUT
0	Dimmer	CH 1-2	0	Dimmer	CH 1-3	0	Dimmer	CH 1-4
1	CCT	CH 1-2	1	CCT	CH 1-3	1	CCT	CH 1-4
2	Dimmer	CH 3-4	2	Dimmer	CH 4-6	2	Dimmer	CH 5-8
3	CCT	CH 3-4	3	CCT	CH 4-6	3	CCT	CH 5-8
4	Dimmer	CH 5-6	4	Dimmer	CH 7-9	4	Dimmer	CH 9-12
5	CCT	CH 5-6	5	CCT	CH 7-9	5	CCT	CH 9-12
6	Dimmer	CH 7-8	6	Dimmer	CH 10-12			
7	CCT	CH 7-8	7	CCT	CH 10-12			
8	Dimmer	CH 9-10						
9	CCT	CH 9-10						
10	Dimmer	CH 11-12						
11	CCT	CH 11-12						

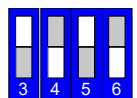

Gestione dei canali in parallelo (DIP 3 settato in "ON")

Var	Funzione	OUT	Var	Funzione	OUT	Var	Funzione	OUT
0	Dimmer	CH TUTTI	0	Dimmer	CH TUTTI	0	Dimmer	CH TUTTI
1	CCT	CH TUTTI	1	CCT	CH TUTTI	1	CCT	CH TUTTI

MAPPA: SMART HSV





MAPPA	Funzione																															
Smart SHV	Master Dimmer	Master Dimmer (Valore Intensità) 0 .. 255																														
	Correzione Temp. Colore	Correzione della Temperatura Colore 0 ..255																														
	Hue	Hue 0 .. 255																														
	Hue Rotation (rainbow) Time	Stop	0 .. 25	3s	26 .. 51	6s	52 .. 76	15s	77..102	30s	103..127	1'	128..153	3'	154..179	6'	180..204	15'	205..230	30'	231..254											
		Hue Fine	0 .. 15	Hold	16..25																											
	Saturazione	Saturazione 0 .. 255																														
Strobo Rate	steady	0..15	blackout	16..31	1fps	32..47	2fps	48..63	3fps	64..79	4fps	80..95	5fps	96..111	6fps	112..127	7fps	128..143	8fps	144..159	9fps	160..175	10fps	176..191	12fps	192..207	14fps	208..223	16fps	224..239	steady	240..254

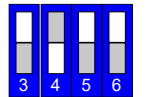
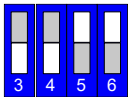

**ASSEGNAZIONE INDIRIZZI IN BASE ALLA TIPOLOGIA DEL CARICO**

Gestione dei canali singolarmente (DIP 3 settato in "OFF")					
RGB			RGBW		
Var	Funzione	OUT	Var	Funzione	OUT
0	DIMMER	CH 1,2,3	0	DIMMER	CH 1,2,3,4
1	CCT	CH 1,2,3	1	CCT	CH 1,2,3,4
2	HUE	CH 1,2,3	2	HUE	CH 1,2,3,4
3	Rainbow	CH 1,2,3	3	Rainbow	CH 1,2,3,4
4	Saturazione	CH 1,2,3	4	Saturazione	CH 1,2,3,4
5	Strobo	CH 1,2,3	5	Strobo	CH 1,2,3,4
6	DIMMER	CH 4,5,6	6	DIMMER	CH 5,6,7,8
7	CCT	CH 4,5,6	7	CCT	CH 5,6,7,8
8	HUE	CH 4,5,6	8	HUE	CH 5,6,7,8
9	Rainbow	CH 4,5,6	9	Rainbow	CH 5,6,7,8
10	Saturazione	CH 4,5,6	10	Saturazione	CH 5,6,7,8
11	Strobo	CH 4,5,6	11	Strobo	CH 5,6,7,8
12	DIMMER	CH 7,8,9	12	DIMMER	CH 9,10,11,12
13	CCT	CH 7,8,9	13	CCT	CH 9,10,11,12
14	HUE	CH 7,8,9	14	HUE	CH 9,10,11,12
15	Rainbow	CH 7,8,9	15	Rainbow	CH 9,10,11,12
16	Saturazione	CH 7,8,9	16	Saturazione	CH 9,10,11,12
17	Strobo	CH 7,8,9	17	Strobo	CH 9,10,11,12
18	DIMMER	CH 10,11,12			
19	CCT	CH 10,11,12			
20	HUE	CH 10,11,12			
21	Rainbow	CH 10,11,12			
22	Saturazione	CH 10,11,12			
23	Strobo	CH 10,11,12			

Gestione dei canali in parallelo (DIP 3 settato in "ON")					
RGB			RGBW		
Var	Funzione	OUT	Var	Funzione	OUT
0	DIMMER	CH TUTTI	0	DIMMER	CH TUTTI
1	CCT	CH TUTTI	1	CCT	CH TUTTI
2	HUE	CH TUTTI	2	HUE	CH TUTTI
3	Rainbow	CH TUTTI	3	Rainbow	CH TUTTI
4	Saturazione	CH TUTTI	4	Saturazione	CH TUTTI
5	Strobo	CH TUTTI	5	Strobo	CH TUTTI



MAPPA: RGB

MAPPA	Funzione	
RGB	R	Dimmer R (Valore Intensità) 0 .. 255
	G	Dimmer G (Valore Intensità) 0 .. 255
	B	Dimmer B (Valore Intensità) 0 .. 255

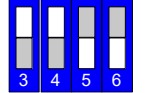
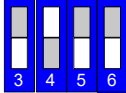

ASSEGNAZIONE INDIRIZZI IN BASE ALLA TIPOLOGIA DEL CARICO

Gestione dei canali singolarmente (DIP 3 settato in "OFF")					
RGB			RGBW		
Var	Funzione	OUT	Var	Funzione	OUT
0	R	CH 1	0	R	CH 1
1	G	CH 2	1	G	CH 2
2	B	CH 3	2	B	CH 3
3	R	CH 4	3	R	CH 5
4	G	CH 5	4	G	CH 6
5	B	CH 6	5	B	CH 7
6	R	CH 7	6	R	CH 9
7	G	CH 8	7	G	CH 10
8	B	CH 9	8	B	CH 11
9	R	CH 10			
10	G	CH 11			
11	B	CH 12			

Gestione dei canali in parallelo (DIP 3 settato in "ON")					
RGB			RGBW		
Var	Funzione	OUT	Var	Funzione	OUT
0	R	CH 1,4,7,10	0	R	CH 1,5,9
1	G	CH 2,5,8,11	1	G	CH 2,6,10
2	B	CH 3,6,9,12	2	B	CH 3,7,11



MAPPA: RGBW

MAPPA	Funzione	
RGBW	R	Dimmer R (Valore Intensità) 0 .. 255
	G	Dimmer G (Valore Intensità) 0 .. 255
	B	Dimmer B (Valore Intensità) 0 .. 255
	W	Dimmer W (Valore Intensità) 0 .. 255

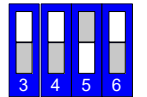
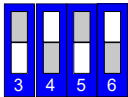

ASSEGNAZIONE INDIRIZZI IN BASE ALLA TIPOLOGIA DEL CARICO

Gestione dei canali singolarmente (DIP 3 settato in "OFF")					
RGB			RGBW		
Var	Funzione	OUT	Var	Funzione	OUT
0	R	CH 1	0	R	CH 1
1	G	CH 2	1	G	CH 2
2	B	CH 3	2	B	CH 3
3	W	CH 1-3	3	W	CH 4
4	R	CH 4	4	R	CH 5
5	G	CH 5	5	G	CH 6
6	B	CH 6	6	B	CH 7
7	W	CH 4-6	7	W	CH 8
8	R	CH 7	8	R	CH 9
9	G	CH 8	9	G	CH 10
10	B	CH 9	10	B	CH 11
11	W	CH 7-9	11	W	CH 12
12	R	CH 10			
13	G	CH 11			
14	B	CH 12			
15	W	CH 10-12			

Gestione dei canali in parallelo (DIP 3 settato in "ON")					
RGB			RGBW		
Var	Funzione	OUT	Var	Funzione	OUT
0	R	CH 1,4,7,10	0	R	CH 1,5,9
1	G	CH 2,5,8,11	1	G	CH 2,6,10
2	B	CH 3,6,9,12	2	B	CH 3,7,11
3	W	CH TUTTI	3	W	CH TUTTI



MAPPA: MRGB+

MAPPA	Funzione	
MRGB+	Master Dimmer	Master Dimmer (Valore Intensità) 0 .. 255
	R	Dimmer R (Valore Intensità) 0 .. 255
	G	Dimmer G (Valore Intensità) 0 .. 255
	B	Dimmer B (Valore Intensità) 0 .. 255
	Strobo Rate	steady blackout 1fps 2fps 3fps 4fps 5fps 6fps 7fps 8fps 9fps 10fps 12fps 14fps 16fps steady 0..15 16..31 32..47 48..63 64..79 80..95 96..111 112..127 128..143 144..159 160..175 176..191 192..207 208..223 224..239 240..254

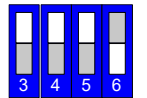
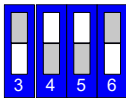

ASSEGNAZIONE INDIRIZZI IN BASE ALLA TIPOLOGIA DEL CARICO

Gestione dei canali singolarmente (DIP 3 settato in "OFF")					
RGB			RGBW		
Var	Funzione	OUT	Var	Funzione	OUT
0	MASTER DIMMER	CH 1-3	0	MASTER DIMMER	CH 1-3
1	R	CH 1	1	R	CH 1
2	G	CH 2	2	G	CH 2
3	B	CH 3	3	B	CH 3
4	STROBO RATE	CH 1-3	4	STROBO RATE	CH 1-3
5	MASTER DIMMER	CH 4-6	5	MASTER DIMMER	CH 5-7
6	R	CH 4	6	R	CH 5
7	G	CH 5	7	G	CH 6
8	B	CH 6	8	B	CH 7
9	STROBO RATE	CH 4-6	9	STROBO RATE	CH 5-7
10	MASTER DIMMER	CH 7-9	10	MASTER DIMMER	CH 9-11
11	R	CH 7	11	R	CH 9
12	G	CH 8	12	G	CH 10
13	B	CH 9	13	B	CH 11
14	STROBO RATE	CH 7-9	14	STROBO RATE	CH 9-11
15	MASTER DIMMER	CH 10-12			
16	R	CH 10			
17	G	CH 11			
18	B	CH 12			
19	STROBO RATE	CH 10-12			

Gestione dei canali in parallelo (DIP 3 settato in "ON")					
RGB			RGBW		
Var	Funzione	OUT	Var	Funzione	OUT
0	MASTER DIMMER	CH TUTTI	0	MASTER DIMMER	CH 1,2,3,5,6,7,9,10,11
1	R	CH 1,4,7,10	1	R	CH 1,5,9
2	G	CH 2,5,8,11	2	G	CH 2,6,10
3	B	CH 3,6,9,12	3	B	CH 3,7,11
4	STROBO RATE	CH TUTTI	4	STROBO RATE	CH TUTTI



MAPPA: MRGBW+

MAPPA	Funzione	
MRGBW+	Master Dimmer	Master Dimmer (Valore Intensità) 0 .. 255
	R	Dimmer R (Valore Intensità) 0 .. 255
	G	Dimmer G (Valore Intensità) 0 .. 255
	B	Dimmer B (Valore Intensità) 0 .. 255
	W	Dimmer W (Valore Intensità) 0 .. 255
	Strobo Rate	steady 0..15   blackout 16..31   1fps 32..47   2fps 48..63   3fps 64..79   4fps 80..95   5fps 96..111   6fps 112..127   7fps 128..143   8fps 144..159   9fps 160..175   10fps 176..191   12fps 192..207   14fps 208..223   16fps 224..239   steady 240..254

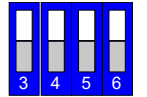
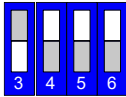

ASSEGNAZIONE INDIRIZZI IN BASE ALLA TIPOLOGIA DEL CARICO

Gestione dei canali singolarmente (DIP 3 settato in "OFF")					
RGB			RGBW		
Var	Funzione	OUT	Var	Funzione	OUT
0	MASTER DIMMER	CH 1-3	0	MASTER DIMMER	CH 1-4
1	R	CH 1	1	R	CH 1
2	G	CH 2	2	G	CH 2
3	B	CH 3	3	B	CH 3
4	W	CH 1-3	4	W	CH 4
5	STROBO RATE	CH 1-3	5	STROBO RATE	CH 1-4
6	MASTER DIMMER	CH 4-6	6	MASTER DIMMER	CH 5-8
7	R	CH 4	7	R	CH 5
8	G	CH 5	8	G	CH 6
9	B	CH 6	9	B	CH 7
10	W	CH 4-6	10	W	CH 8
11	STROBO RATE	CH 4-6	11	STROBO RATE	CH 5-8
12	MASTER DIMMER	CH 7-9	12	MASTER DIMMER	CH 9-12
13	R	CH 7	13	R	CH 9
14	G	CH 8	14	G	CH 10
15	B	CH 9	15	B	CH 11
16	W	CH 7-9	16	W	CH 12
17	STROBO RATE	CH 7-9	17	STROBO RATE	CH 9-12
18	MASTER DIMMER	CH 10-12			
19	R	CH 10			
20	G	CH 11			
21	B	CH 12			
22	W	CH 10-12			
23	STROBO RATE	CH 10-12			

Gestione dei canali in parallelo (DIP 3 settato in "ON")					
RGB			RGBW		
Var	Funzione	OUT	Var	Funzione	OUT
0	MASTER DIMMER	CH TUTTI	0	MASTER DIMMER	CH TUTTI
1	R	CH 1,4,7,10	1	R	CH 1,5,9
2	G	CH 2,5,8,11	2	G	CH 2,6,10
3	B	CH 3,6,9,12	3	B	CH 3,7,11
4	W	CH TUTTI	4	W	CH 4,8,9
5	STROBO RATE	CH TUTTI	5	STROBO RATE	CH TUTTI



## ➤ FUNZIONI DI LETTURA E SCRITTURA SUPPORTATE – MODBUS RTU

Function code		
0x01	Read Coils	x
0x02	Read Discrete Inputs	x
0x03	Read Holding Registers	✓
0x04	Read Input Register	x
0x05	Write Single Coil	x
0x06	Write Single Register	✓
0x07	Read Exception Status	x
0x08	Diagnostic	x
0x0B	Get Com Event Counter	x
0x0C	Get Com Event Log	x
0x0F	Write Multiple Coils	x
0x10	Write Multiple Registers	✓
0x11	Report Server ID	x
0x14	Read File Record	x
0x15	Write File Record	x
0x16	Mask Write Register	x
0x17	Read/Write Multiple Registers	x
0x18	Read FIFO queue	x
0x2B	Read Device Identification	x